

Pulsonix PCB

Advanced Schematic & PCB
Design Environment

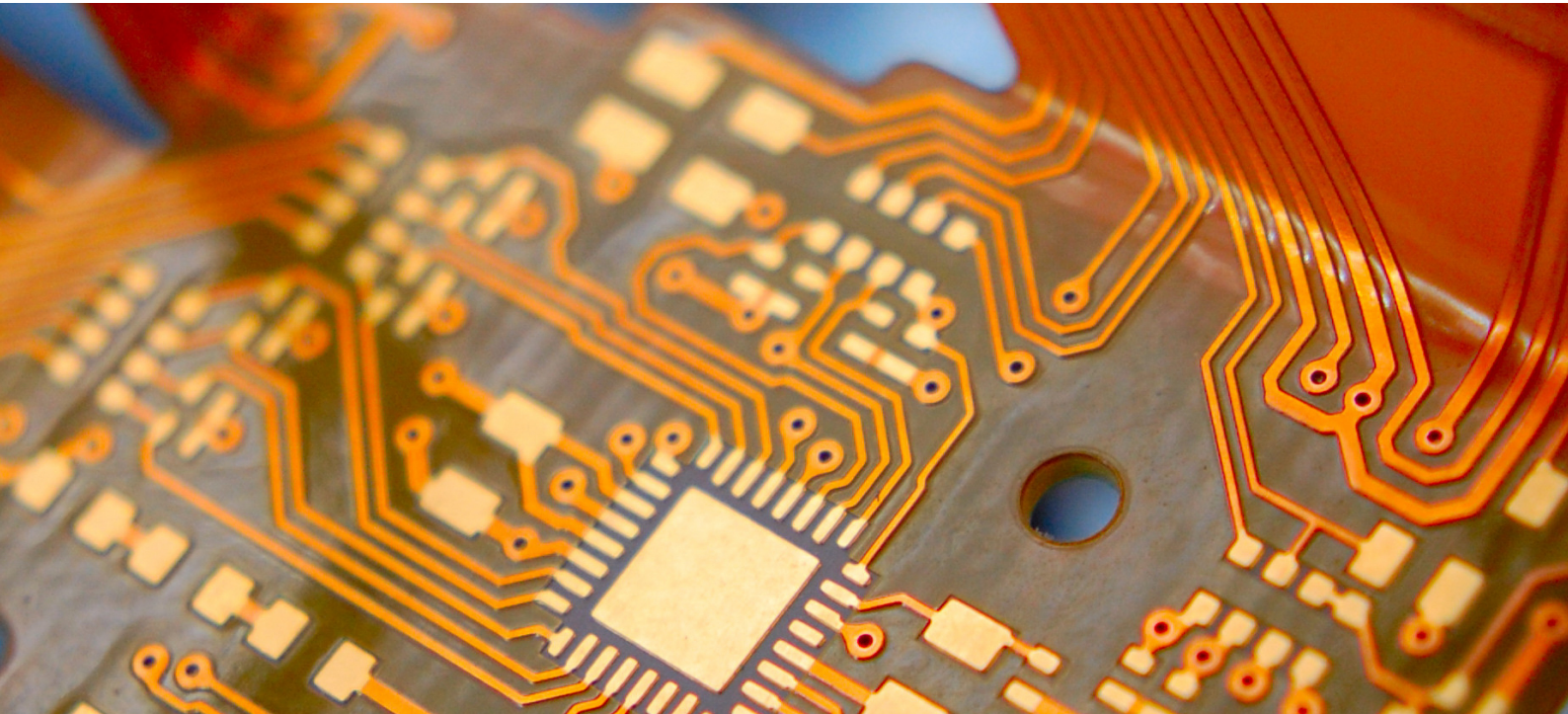

PULSONIX
— 

Pulsonix - a complete design suite

A Complete Design Suite

Built on a portable and flexible high-tech modern 'mosaic' architecture, Pulsonix is well structured and has been designed for the challenging needs of today's environment. Ready to Use and Easy to Learn Pulsonix is ready-to-use right out of the box. Supplied with comprehensive libraries and technology files for fast start-up, you can be up and running instantly. With an intuitive user interface, Pulsonix can be used with no need for formal training. The learning curve is very short, even for less experienced users.

Peace of Mind with Superior Quality

The Pulsonix team throughout the company is highly customer focused; every activity is centred on you, the customer. Our support and service is totally unparalleled with any other EDA vendor; this is in addition to a leading quality product. The Pulsonix brand is synonymous with quality and

service. Once you purchase the product you'll be buying into the reassurance that you will be well looked after throughout every stage of the process.

5-Star Service

Pulsonix is widely known for its high quality features and efficient after-sales care. Our service has been given a 5-star rating by our customers, proving that your service and support are a high priority to us.

Low Cost of Ownership

As well as being an affordable solution, Pulsonix has one of the lowest annual maintenance pricing structures in the market today. The price is reflective of what we believe it should be; not the over-inflated costs of some of the legacy products in today's market.

“ Pulsonix is our new ECAD standard tool for Schematics, simulation and PCB design. It has been chosen for its modern easy-to-use interface and its perfect price/performance ratio. ”

O. Hollinger, Carl Zeiss AG.

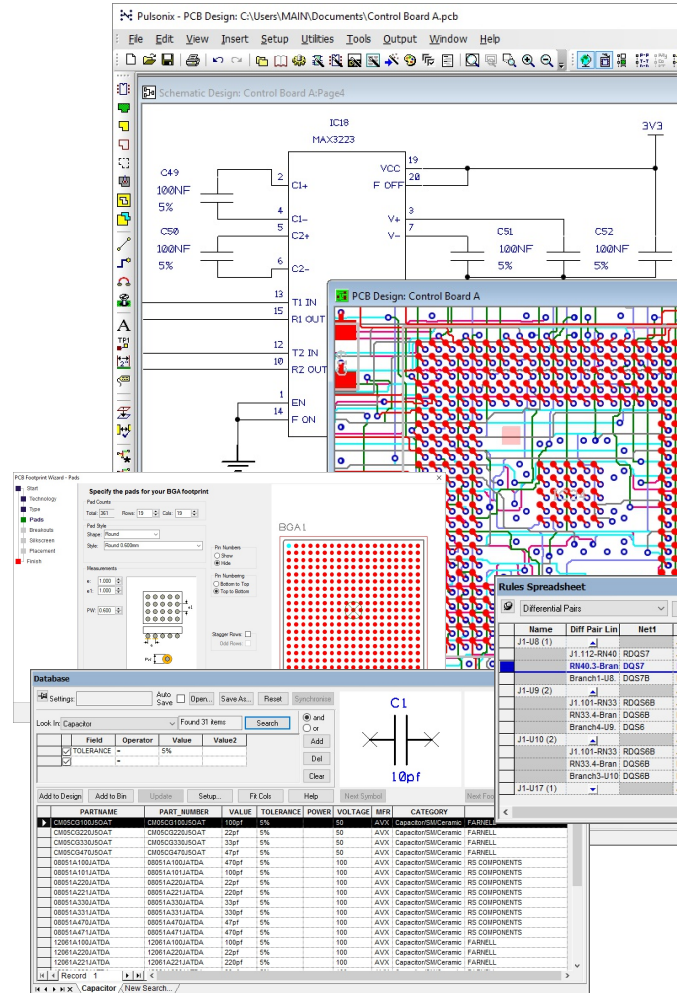

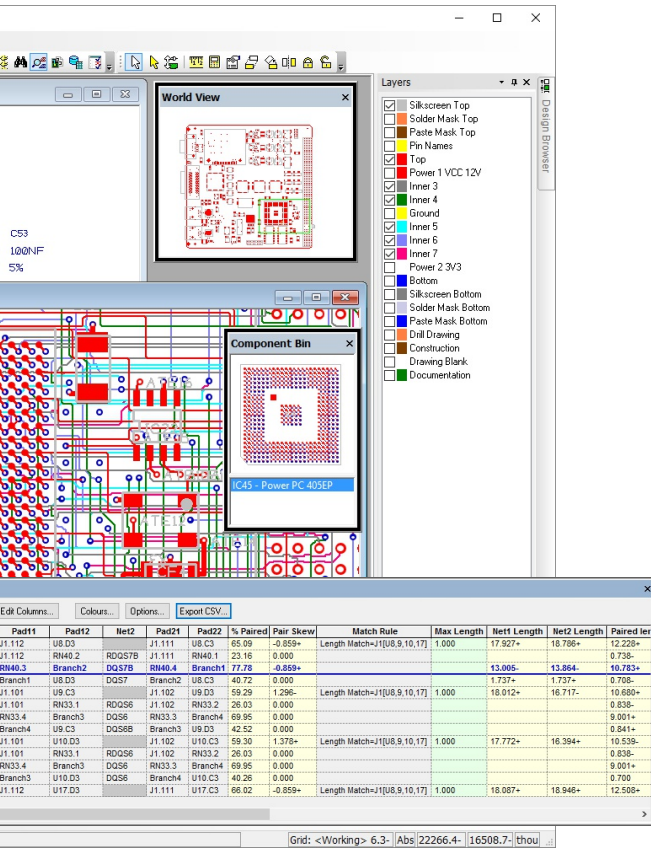

With a clear display of Constraint rules, the High Speed rules spreadsheet dynamically reports values back in real time

Scalable solutions

All Pulsonix products have the same core structure and are ready to use. Each is supplied with Schematic Capture, PCB Layout and our Autorouter. A comprehensive Parts library and tools to manage and create them are also supplied. Once your needs grow, Pulsonix can be further enhanced with our speciality range of add-on options; such as Interactive High Speed design or the Database Connection modules for example. Our options are standalone so they don't rely on another other option being available.

Import your existing CAD data
Pulsonix imports Schematic & PCB Designs and Libraries using the industries largest and most accurate selection of import filters:

- Altium DXP & Altium Designer
- P-CAD
- CadStar
- Eagle
- OrCAD Capture & Layout
- Cadence Allegro
- PADS PowerView & Power PCB
- Mentor Expedition
- Zuken Visula
- Zuken System Designer SCM
- Viewlogic Viewdraw
- DxDesigner Schematics
- Accel, Tango/Accel EDA
- Protel SE '98 & SE '99
- TopCAD/Integra
- UltiCAP/UltiBoard
- DesignSpark
- Easy-PC
- PCB Artist
- Gerber files

“ Pulsonix has proved to be an excellent choice for Crowcon, enabling us to keep to R&D deadlines. Pulsonix has paid for itself many times over in reduced development times and savings on bureau costs.

A. Beasley, Crowcon Ltd. ”

Fast, intelligent Schematic creation

Create Clear and Concise Schematics

Create clear and concise schematic drawings in this easy-to-use design environment. No tedious menus or commands to navigate with modeless operation and intuitive fast usage.

Custom Electrical Rules Checking

Electrical Rules Checking (ERC) both online as you design and as an interactive batch mode are readily available to ensure your custom electrical rules are adhered to at all times during the circuit creation. All ERC violations are instantly notified to you so you can take corrective action.

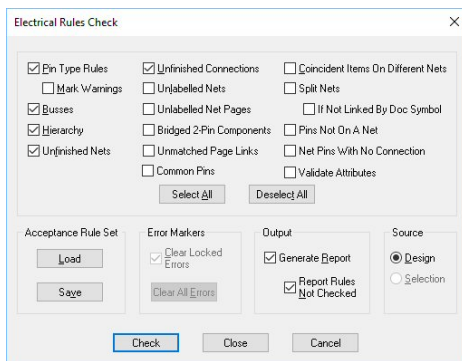

User configurable ERC Rules - essential for right first time design

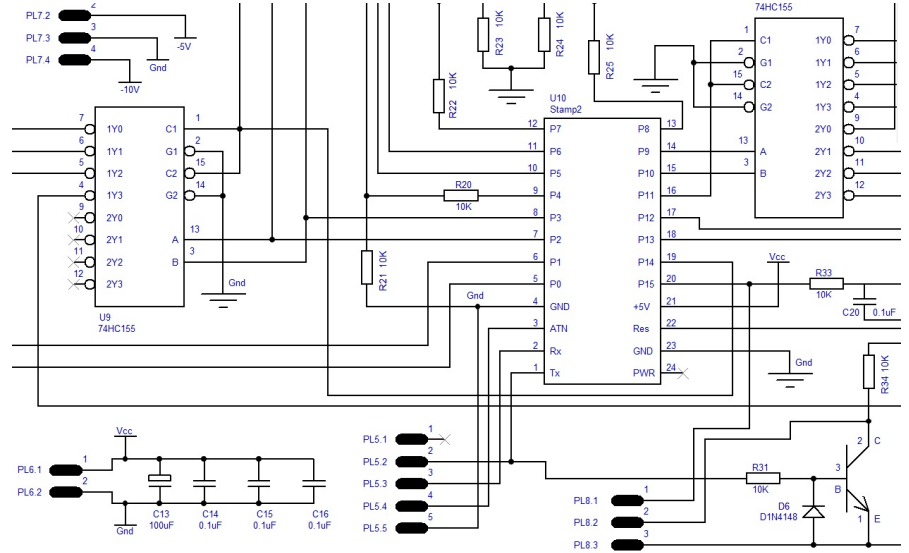

Flat Sheet & Multi-level Hierarchical Design

Pulsonix hierarchy enables you to break circuitry into functional elements allowing you to define the detail of each element as a block. You can alternatively re-use of commonly used circuit elements using pre-defined blocks to build a solution.

Sketch Connections

Interactive Schematic Routing enables you to guide the routing path for electrical connections within your schematic design. With point-to-point routing and 'sketch' path mode, schematic connection routing has never been so easy and fast.

Forwards & Backwards Design Annotation

Send design changes and ECO's to the PCB or make changes in the PCB and back-annotate them to the Schematic however your design process dictates.

Instant Cross Probing

Cross probe bi-directionally between your Schematic and PCB designs. Click on the Component or connection in the Schematic and see the corresponding Component instantly highlighted in the PCB, or click on a footprint or track in PCB and see it highlighted in the Schematic.

Use the Symbol Wizard to quickly create Symbols

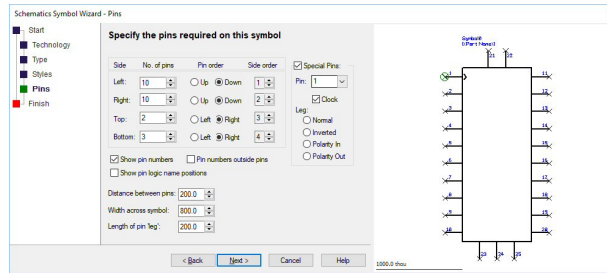

Intelligent Buses

Intelligent buses can be added to your design in one movement. 'Open' and 'Closed' busses are flexible and powerful. Bus nets can be drawn with connective nets to lower-level hierarchy or left named for full implied (invisible) connectivity.

Intelligent PDF Export

Export your designs to an intelligent PDF file. Drawings and designs can be interrogated using the PDF file without the need to send the actual design file or load Pulsonix. Every design item can be queried and critical properties displayed.

Design Variants

Define and visualise any number of Part and Assembly variants in your Schematic design and automatically transfer these through to the PCB.

Multiple Netlist Export

Export netlists from Pulsonix to other industry standard vendor formats such as ViewLogic, EDIF, OrCAD etc. Use the Pulsonix Schematic design editor as your choice for quick and reliable circuit capture.

Schematic Symbol Wizard

Takes you through creation of the symbol in a step-by-step sequence to easily produce regular symbols. The pin sizes, positions and numbering is selected to make symbol creation so simple and error free.

Attribute Editor

The attribute editor enables editing of properties and critical information in the design using the powerful spreadsheet style editor. Quickly Copy/Paste attributes and parameters into the cells for Components, nets and pins.

Integrate Spice Simulator Interface

Pulsonix Schematics is supplied with an integrated interface to industry Spice simulators, such as LTSpice, enabling your designs to be tried and tested at the very earliest stages; proofing the design concept up-front reducing the need for physical prototypes. Utilise the same Pulsonix library for Spice as both Schematic and PCB designs without the need for external libraries or Schematic recreation. The Spice engine of choice can be driven directly from Pulsonix Schematics using probes, primitives and sources within the Pulsonix library.

Feature Summary

- Integrated Schematics and PCB
- 80,000 Part library as standard
- 15+ million Parts in Component Search Engine
- True instanced Schematic hierarchy
- Drag & drop design methodology
- Fast menu-less operation
- Sketch connection mode
- Single-shot printing & plotting
- Export netlist to other PCB systems
- Intelligent Buses
- Instant cross probing
- Forwards & backwards annotation
- Style sheet templates
- Customisable drawing & title blocks
- Define constraint rules at Schematic stage
- Schematic symbol wizard
- Intelligent Component & Net naming
- Star Point & Testpoint definition
- Interface to Spice simulators

Powerful PCB - yet easy to setup and use

Constraint Rules

Define and manage your constraint rules using the constraint manager. All rules previously defined in the Schematic editor are seamlessly passed through into the PCB design ready for use. Net Class and Class to Class parameters can be defined for nets where length and spacing rules need to be restricted.

DFM/DFT Rules

Powerful design rules for manufacturing and test can be defined in addition to Pulsonix' comprehensive set of DRC rules. Following definition, checking is quickly made with all errors and warnings displayed in the Error Browser. Each violation can be easily identified from the sorted list and dynamically reviewed in the design by simply clicking the rule error.

Custom Pads

Where standard pad shapes don't exist, Pulsonix allows you to create complex pad shapes; even unorthodox shapes such as touch switches where the drill is exposed. Custom pads can be created for any layer or stack.

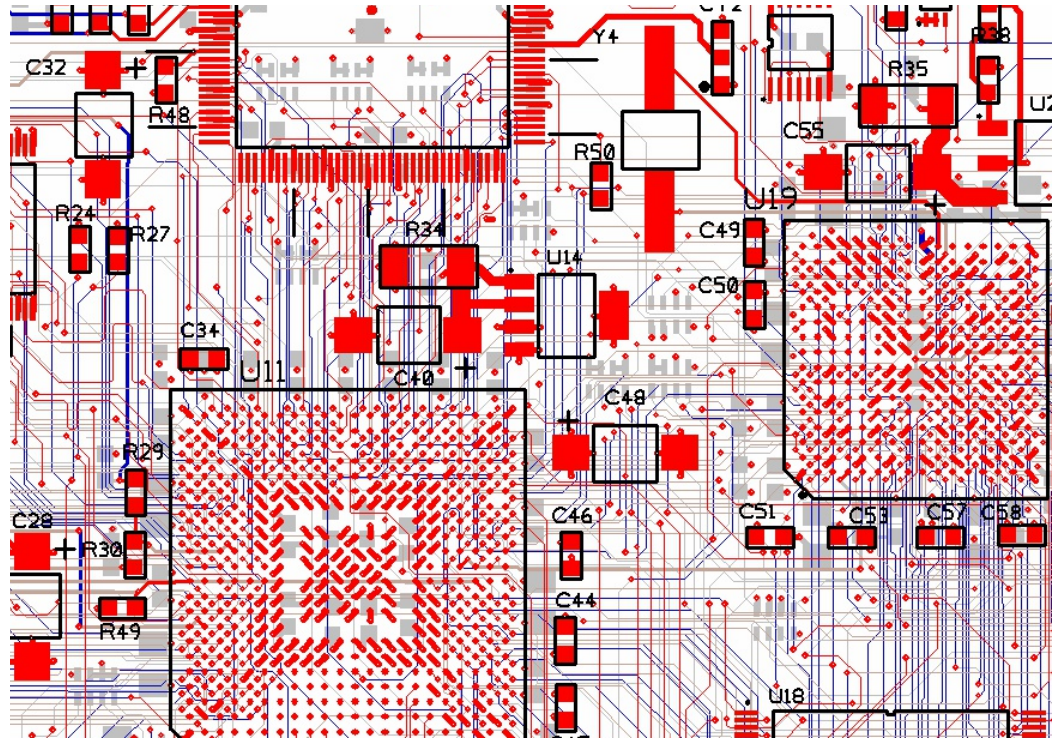

Thermal Rules

Using the Technology manager, add thermal rules for nets, net classes, areas and individual objects. Control over thermal relief on pads is provided for shape, spoke direction, number of spokes and connect/no connect status.

Curved/Filletted Tracks

All track shape styles can be changed on-the-fly using the context menu. Change between orthogonal, angled, any angle and curved tracks. Angled tracks can be filletted, blending them between each other. Further blending can be achieved using the teardrop function.

Powerfull Report Generator

The powerful Report Maker feature enables complex reports and netlists to be created using the easy-to-use dialog. ASCII-based Pick and Place reports, interfaces to assembly and manufacturing tools can be created with ease.

Technology Support

Pulsonix supports a range of technologies from through-hole to blind and buried vias and including micro-vias. Laser and plasma 'drilled' micro-vias are created with 'entry' and 'stop' pads and can be combined to create composite stacked and tapered vias.

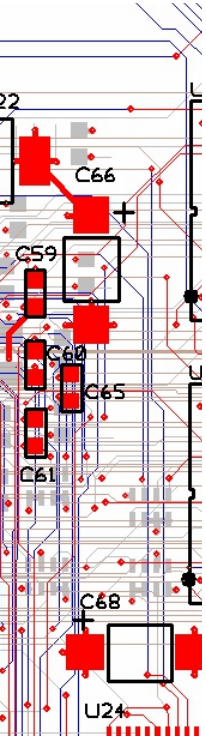

Bring your PCB to life with photo-realistic 3D images within Pulsonix

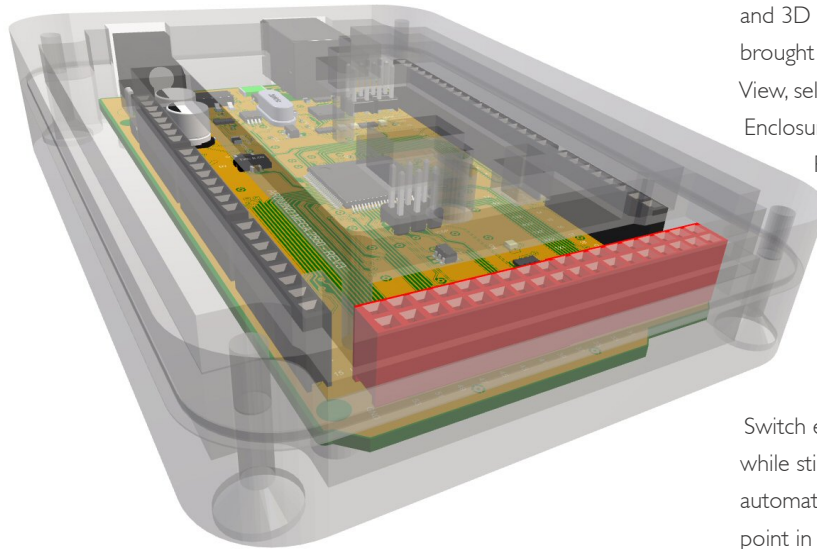

Co-Design in PCB 3D Environment

By co-designing in the integrated Pulsonix PCB and 3D design editor, MCAD processes are brought further forward in the design process. View, select and move Components and Enclosures in the STEP preview environment.

Perform clash or collision detection, view and measure the exact point of clashing and rectify clashes between items all within the 3D preview. View your board as an exploded view allowing you to inspect the inner layer structures.

Switch enclosure transparency to view 'inside' while still view the case. All changes are automatically annotated into the PCB. At any point in the process, use the bidirectional STEP transfer to interface to your MCAD system.

ECAD-MCAD 3D Integration

Pulsonix bridges your MCAD-ECAD flows with the integrated STEP Preview and support for DXF and IDF import and export for alternative MCAD integration. Pulsonix also supports the IPC-2581 as an export format.

Construction Lines

Unique to Pulsonix, construction lines provide user-definable lines within your design from which to guide your design items. Use construction lines to create complex board outlines or align irregular shapes or design items. As well as lines, arcs and circles can also be added. Additional functionality provides the ability to hug items, divide circles or arcs, bisect shapes and to snap to existing shapes, this is a very versatile tool.

Reverse Engineering

Intelligently rebuild a Gerber file back to a 'connective' design as if it were originally designed in Pulsonix. Rebuild Components from this data too or replace them from your library where they already exist. Everything is rebuilt, connected and correctly structured. Finally, rebuild the design to a matching Schematic, complete with placement and connections. Import bitmaps of scanned boards where nothing else exists!



PCB - all the tools in one environment

Complex high speed designs
can be created using Pulsonix

Manufacturing Outputs

Extensive manufacturing outputs are exported - Gerber, Excellon, ODB++, Windows, HPGL, IPC-2581, IPC-356, PDF plus a fully customisable Report Maker interface to create company reports, BOMs, netlists and assembly placement outputs as you require.

Design & Part Variants

Using the Variant Manager, easily create any number of variants, defined at either the Schematic or the PCB design stage. If using the Schematic as the master, the variant information will be automatically transferred to the PCB design. Detailed Part variants can be easily created. Pulsonix allows Fitted/Not Fitted, different Part, Footprint, Attributes/Values, and even a different number of footprint pins per component.

FPGA Integration

As standard, Pulsonix is supplied with a built-in FPGA interface to integrate with the Altera Quartus II or Xilinx ISE development systems.

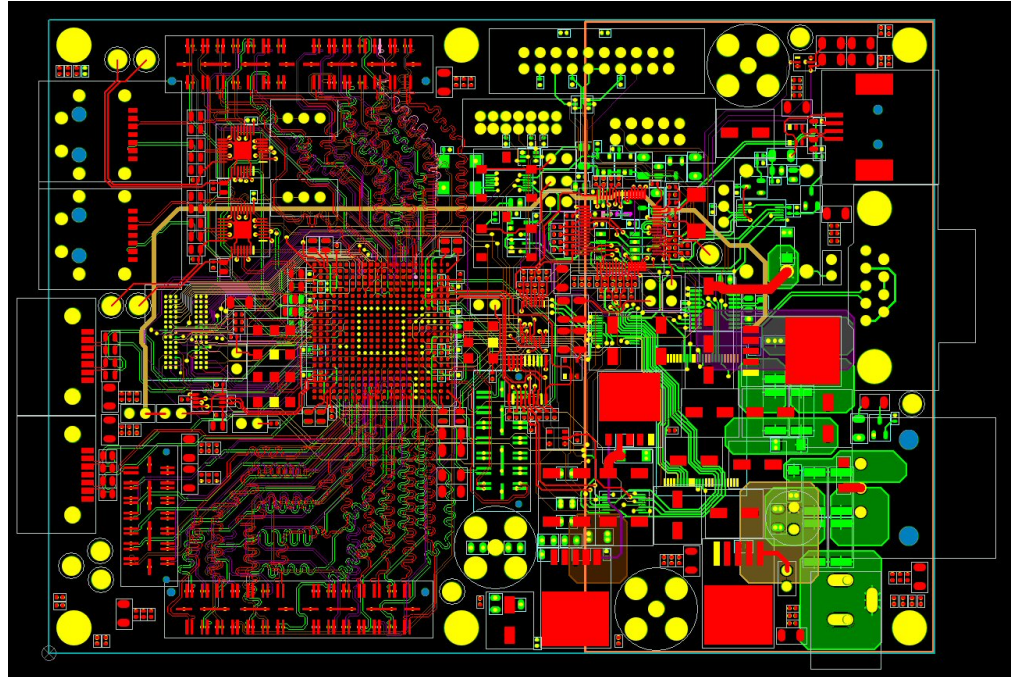

Scripting support

The ActiveX Scripting Host scripting engine in Pulsonix provides a powerful programming interface that allows you to write scripts to carry out specific tasks in the application. Carry out a task or access specific details of design data that is not directly possible through the user interface. Scripting can provide you with the possibility of doing that, without having to wait for

new features or outputs to be created in the actual Pulsonix application. Languages such as VB Script, JAVA Script, PerlScript, Tcl and Python are supported for scripting.

“ It is vitally important that we receive fast response and support from our software tools suppliers. We feel that WestDev are really interested in looking after their customers, and the support we get on Pulsonix is excellent.

Mr Sascha Steiner, Tridonic Atco GmbH

TRIDONIC



Pulsonix is available with over 15 million free Parts and more being created daily

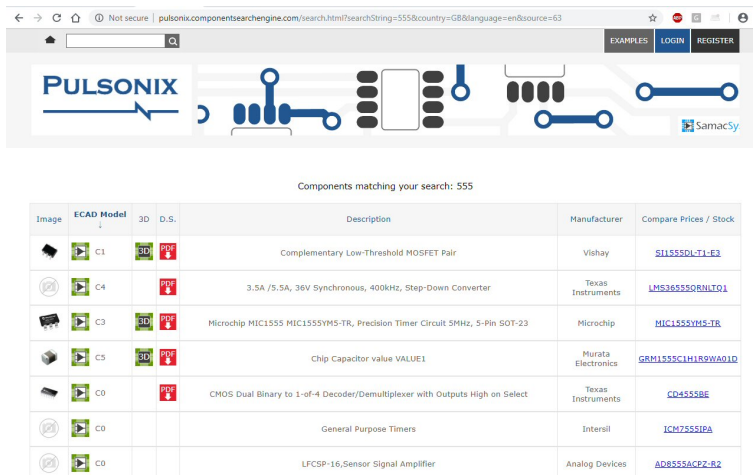

Component Search Engine

Select from a library of over 15 million Parts and download directly on your cursor. All Part information is matched with a choice of Component vendors. With all Parts selected, not only is it ready to use on the end of your cursor, but is also imported into your Pulsonix library ready for use on another project. This facility is free to all Pulsonix users.

Flexi-Rigid Support

True flexi-rigid support is available using the features within Pulsonix; Multi-spanned Layer Areas, Board Outlines and Board Cutouts. Using these powerful options, Board outlines can be created to span 'internal' flexi layers that are still exposed externally. Layer Spanned Components can be placed on flexi layers so that your BOM is truly reflective and reports the all build configurations.

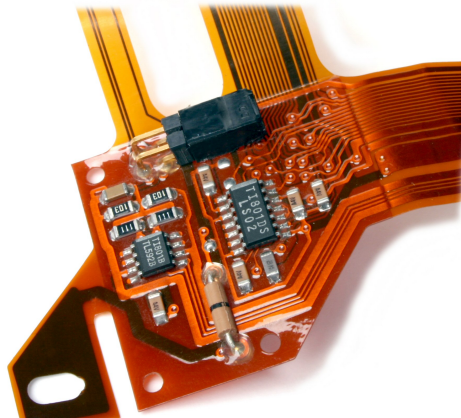

Pulsonix supports true flexi-rigid design

Feature Summary

- Integrated Schematics and PCB
- Supplied with comprehensive library
- Drag & drop methodology throughout
- Fully customisable interface
- Supports true mixed imperial/metric units
- Wizards for fast start-up
- Reverse Engineering from PCB to SCM
- Auto Testpoint insertion & analysis
- Extensive Assembly & Part Variants included
- PTH, Blind, Buried and Micro-via support
- Comprehensive design rules definition
- Track/Via Breakout/fanout support
- Powerful manual & auto placement
- Push aside & Pull-tight routing modes
- Sketch & Bus routing
- Easy, dynamic and flexible copper pouring
- Dynamic Dimensions
- Construction lines for complex shapes
- Subcircuit Design reuse
- DFM/DFT and constraint rules checks
- Hierarchical constraint & spacing rules
- Rules by layer, Attribute and by Area definable
- Star and delta points for multiple signals
- 3D STEP Preview and editor
- 3D STEP Mechanical CAD export/import
- Supports Flexi-rigid boards
- Scripting & macro support
- 5-Star service and support
- Minimal system requirements
- Floating and Loan licensing available
- Educational licensing available



Interactive High Speed option

Constraint Driven Design Rules

Pulsonix delivers a powerful set of constraint rules-driven interactive High Speed design features. Conceived from the Schematic, the design is defined by the engineer during the early logical capture phase. All constraint rules are passed to the PCB design automatically where they are implemented using graphical guidance to ensure the layout is correct. Define high speed rules using the constraint manger: Rules can be defined using Nets, Net Classes, Net Attributes, Signal paths, Sub-Nets, Differential pairs or Paired chains such is the flexibility of this option.

Rules Spreadsheet

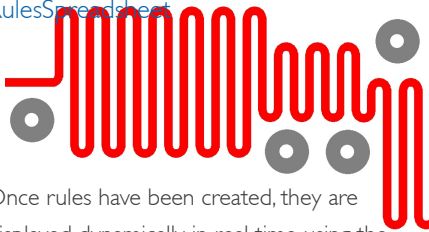

Once rules have been created, they are displayed dynamically in real time using the Rules Spreadsheet which is also fully customisable.

Name	Diff Pair Link	Net1	Pad11	Pad12	Net2	Pad21	Pad22	Pair Skew	Match Rule	Max Length Diff	Paired length	Length	Length Diff	Diff To Targ	Diff To Shortest	Diff T
J1-U8 (1)		J1-112	U8.D3	J1-111	U8.C3	-0.859+			Length Match=J1[U8.9,10,17]	1.000	12.226+	18.846+	A 2.852+	-1.914+	2.392+	-1.911
J1-U9 (2)		J1-101	U9.C3	J1-102	U9.D3	-0.786+			Length Match=J1[U9.5,10,17]	1.000	10.509+	17.872+	A 2.658+	-2.028+	4.116+	-1.911
		J1-101-RN33.1.J	RDQS6B	J1-101	RN33.1	RDQS6	RN33.2	0.000			0.838+					
		RN33.4-Branch3	DQS6B	RN33.4	Branch3	DQS6	RN33.3	Branch4	0.849+		9.001+	12.429+	A			
		Branch4-U9.C3	DQS6	Branch4	U9.C3	DQS6B	Branch3	U9.D3	0.890		0.841+					
J1-U19 (2)		J1-101	U19.D3	J1-102	U19.C3	-0.875+			Length Match=J1[U9.9,10,17]	1.000	10.539+	17.332+	A 2.846+	-2.362+	3.878+	-3.86
J1-U17 (1)		J1-112	U17.D3	J1-111	U17.C3	-0.859+			Length Match=J1[U9.9,10,17]	1.000	12.508+	19.006+	A 2.552+	-0.859+	2.552+	-0.855

Interactive Length Indicators & Head-up Display

During manual routing, optional interactive length indicators and a head-up display show rules and parameters in real time. As rules are violated, they change colour to warn you.

Differential Pair Routing

The advanced constraint rules allow Differential Pairs and Paired Chains to be created easily and quickly. All rules for Differential Pairs can be defined for Layer, Side, Area and Net Attributes. An optional spacing rule between Differential Pair tracks keeps separation precise. When layer swaps are required, you can choose the via pattern to use. The interactive editor displays the legal via pattern available and the new track exit paths.

Serpentine Routing

Various modes with the Serpentine functionality enable different styles to be created, such as Trombone, Octagonal, Curved, Sawtooth and user-defined. Rules sets allow min/max amplitude, cycles and cycle separation

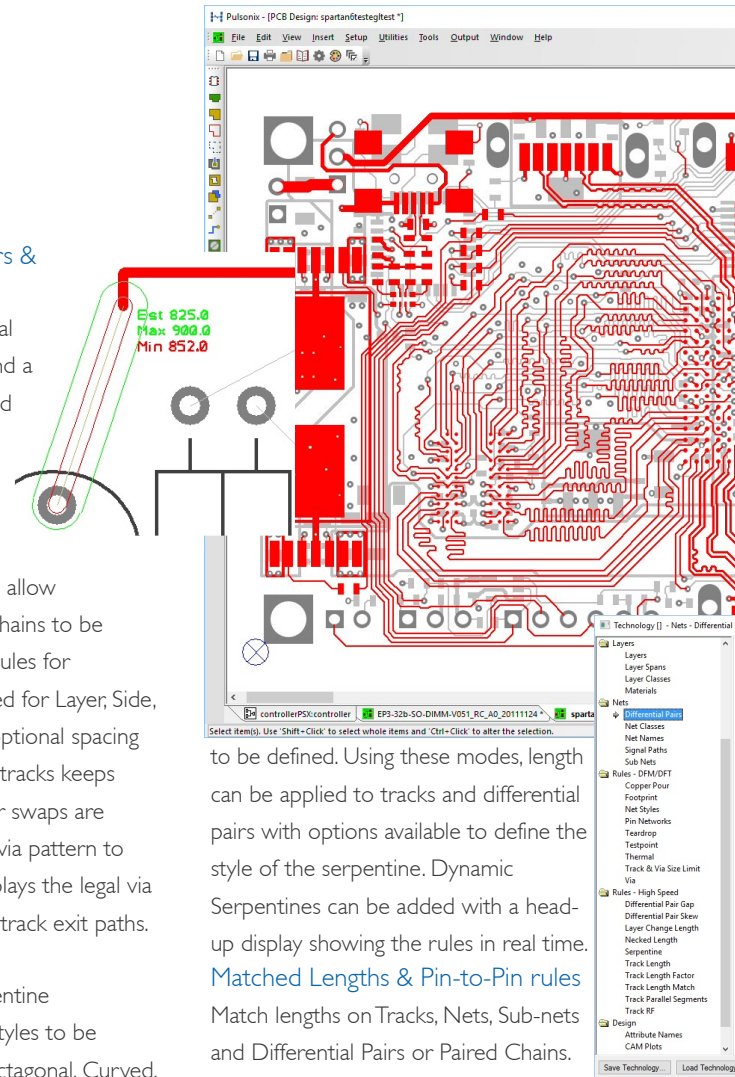

to be defined. Using these modes, length can be applied to tracks and differential pairs with options available to define the style of the serpentine. Dynamic Serpentines can be added with a head-up display showing the rules in real time. Matched Lengths & Pin-to-Pin rules Match lengths on Tracks, Nets, Sub-nets and Differential Pairs or Paired Chains. Pairs and sets of pairs can be matched using the Matched Lengths rules. Define rules for min/max length and the number of vias allowed. Pin to pin lengths can also be defined as part of an overall track path length.

Check constraint rules in real time using the configurable Rules Spreadsheet

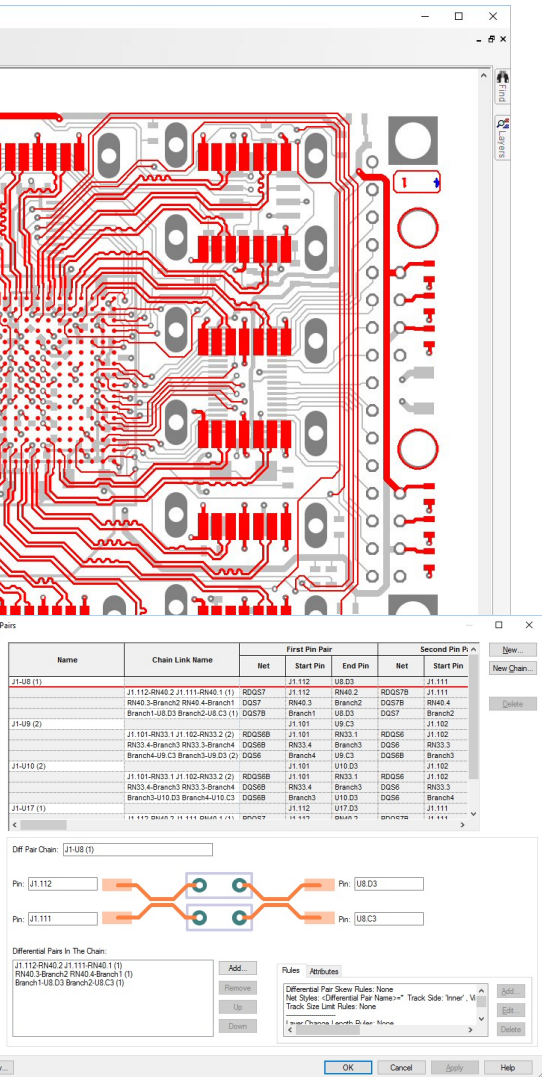

Constraint Rules in the High Speed option enable full control over critical nets

Layer Change Length Rules & Pin Packages

Where layers changes or length through a package is required, these values are factored in using the High Speed rule sets.

Parallel Track Segments & Adjacent Nets

Define rules for the length and proximity of parallelism of adjacent nets. These can be checked against track sets and against the board outline. Design Rules Checks will report nets that violate these rules.

Track Length Factor

When track length needs to be factorised, this can be added to its own rule set and considered for overall track lengths.

Daisy Chain Routing

Where track paths are critical, pin to pin connection order and branch points can be defined. This is especially desirable when creating DDR 1, 2, 3 and 4 circuitry.

RF Design Features

As part of the RF design features, Pulsonix provides functionality to properly support this through square-ended tracks, chamfered track

corners and spiral shapes using intelligent rules.

Feature Summary

- Constraint rules manager
- Rules Spreadsheet
- Differential Pair & Paired Chains
- Pattern control for Diff Pair vias
- Track Length Min/Max rules
- Track Length Matching
- Differential Pair Length Match rules
- Maximum Length deviation rule
- Min/Max Pin-to-Pin length rules
- Head-up display of rules
- Dynamic display of Min/Max rules
- Graphical net length indicators
- Dynamic Serpentine routing
- Serpentine routing modes
- Daisy chain Pin-to-Pin topology rules
- Rules by Layer, Area and Net Attributes
- Parallel Track Segments & Adjacent Nets rules
- Track length factor rules
- Layer change length rules
- Pin Packages length rules
- Spiral creation using intelligent rules
- Circular/square spiral shapes
- Square-ended tracks
- Chamfered track corners for true RF mitres

The Constraint Rules Manager enables you to manage all rules in an easy to use dialog

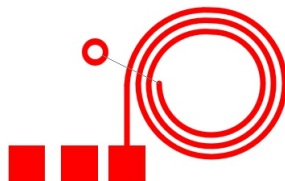

Interactively create spirals using dialog driven rules



Pulsonix Vault

Full data revision control and auditing are available through the Pulsonix Vault

Revision & Version Control with the Pulsonix Vault

Track revision of Parts, Designs, Technologies, Manufacturing files, BOMs & Associated files. The Vault can be local or server based with admin tools to control user access.

Full Revision History

Access full revision history over your Pulsonix data using the Pulsonix Vault. Automatic versioning of your designs and libraries in a controlled manner ensures accuracy and allows for coherent design practises to be managed effectively.

'Where Used' Reporting

The Pulsonix Vault allows you to carry out 'Where Used' analysis to identify exactly where an item is used. You can check if a Part is used in a Hierarchical Block, Schematic or PCB design.

Definable Access Rights

User definable permission levels within the Vault allow you to control who can access, view, edit and save items. Having this functionality helps to ensure you design with known and verified data.

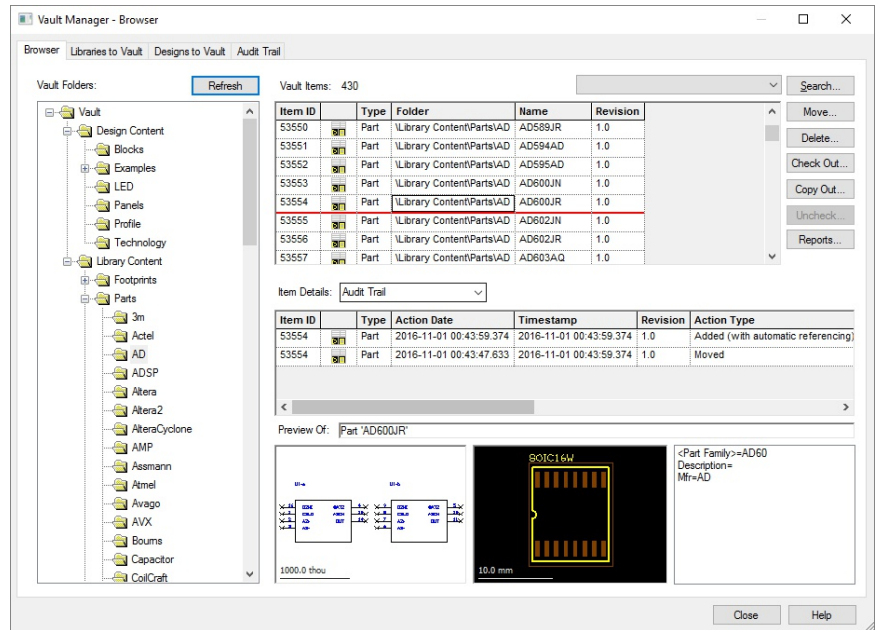

Saved Search Capability

The Pulsonix Vault provides you with the ability to save various search configurations allowing for quick and easy access to known filtered items within your Vault.

Preview Windows

Sometimes a picture paints a thousand words - the Pulsonix Vault allows you to see visual previews of your Parts and their attributes based on the individual revision of the item you select. Selected items already in the Vault can be retrieved and added to the design.

Full Audit History

See what changes were made, when they were made and by whom. Users can obtain full reports which can be filtered by user, action type, date and file type to show an audit history for the selected data.

Feature Summary

- Full Revision History
- Definable Access Rights
- Preview Windows
- Where Used Reporting
- Saved Search Capability
- Full Audit History

Corporate Database Connection for Pulsonix

The Database Connection option enables fast parametric search of your Parts or company database

Industry Standard ODBC Connection

The Pulsonix Database Connection (PDC) connects to manufacturing, engineering and corporate databases using any ODBC connection. It allows access to many databases and other storage formats such as MS Access, MS Excel, CSV, TXT, DBase, Fox, Sage, MySQL and SQLServer for example.

Configuration

A graphical interface is used to configure the system with easy mapping between the 'host' data fields and Pulsonix attribute fields.

Configuration allows critical fields to be defined and checked. Critical fields are those which when checked, must be the same as the database and not 'local' values. A tool to migrate Pulsonix Part data to the database format is also supplied.

Parametric Searching

Up-to-date Parts can be identified from the central database using powerful SQL parametric search criteria from drop-down list selections. Search using keyed parameters will quickly locate suitable Part candidates from the database which you can then further refine to identify the exact Part you require.

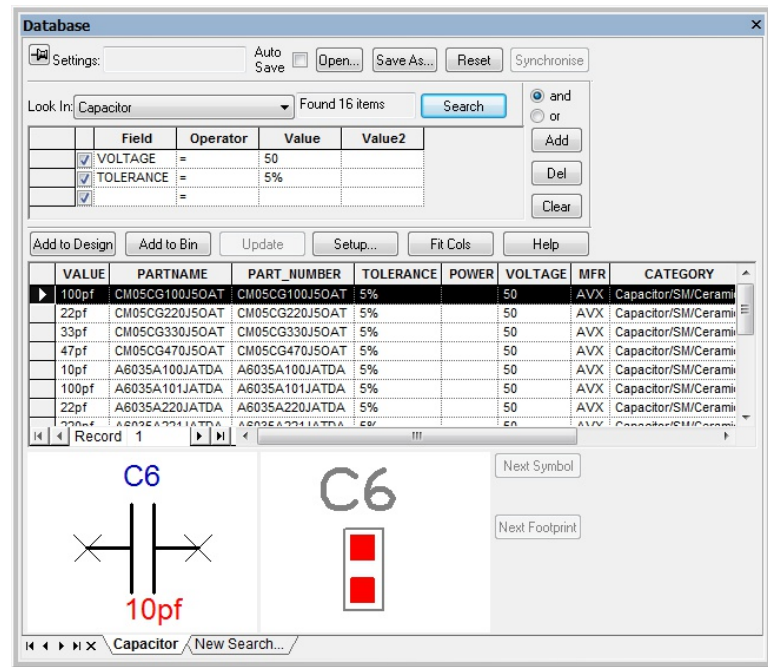

Management Tools

PDC is run from a centralised database resource. The system administrator is able to manage database access and read/write permissions for each user using standard server admin rights. Additional library management control facilities are available when using the PDC with floating Pulsonix licenses.

Drag and Drop Methodology

Searched Parts found can be dropped from the PDC directly into both the Schematic and PCB designs using a simple drag and drop.

Feature Summary

- Connects to corporate databases
- Access many industry standard databases
- Integrated environment within Pulsonix
- Add Parts to both SCM and PCB designs
- Configuration mapping of data fields
- Powerful parametric searching
- Preview windows of Components found
- Part analysis of design items to database
- Report 'local' Parts not in the database
- Check selected Parts or whole design
- Update design based on critical fields

Pulsonix PLM Interface

PLM Interface

PLM or Product Lifecycle Management enables you to manage the design flow. This might be a product that controls tools and data for electronics design and manufacturing. It might also be used in the Pulsonix design environment, mechanical CAD, a costing or manufacturing database, drawing issue control, materials specification or quality control for example.

Tight Integration with Pulsonix

The PLM product interface (or a middle tier application between the PLM system and the various individual tools) allows access to documents and other design data in a controlled manner, so that all actions fit with the design flow defined by the PLM system. Each process product requires its own PLM interface to enable the PLM tool 'hooks' to

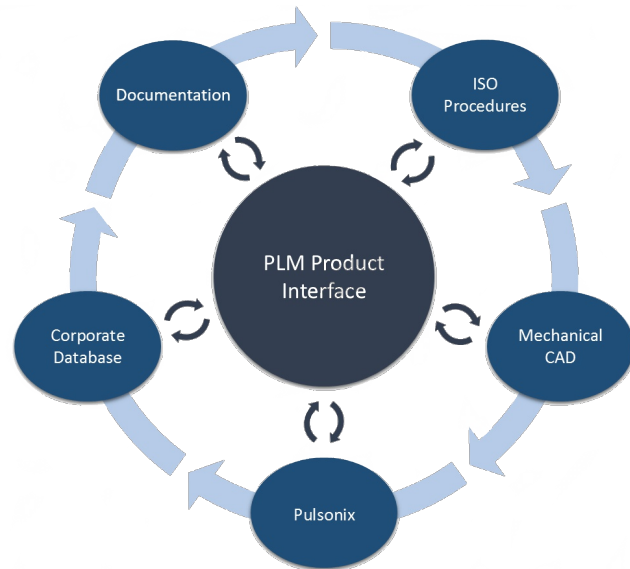

access information within it. Pulsonix has hooks built in which the PLM product can access using the Pulsonix PLM interface. These are programming hooks that are specially written for individual PLM products. For more information about PLM systems supported and the PLM interface, please contact your local Pulsonix service office.

Feature Summary

- Tight integration with Pulsonix
- PLM interface with Integrate product
- Open/Save/Close Designs and Exit program
- CAMPlot manufacturing interface
- Design Rules Checking links
- Process logging of commands to log file
- Set and select Variants in design
- Set current folder
- Select pages of a Schematic
- Get and Set Properties
- Get and Set Parts
- Access attributes
- Access Report Maker format files
- Set printer type
- Reload and Refresh designs
- Write Component instances and attributes
- Additional commands available on demand



Pulsonix Options

Chip On Board Support

The Chip-On-Board option provides features for creation and annotation of die & bond pads and bond wires. Within the Pulsonix design the bond pads are treated as special pads and can move independently of die and

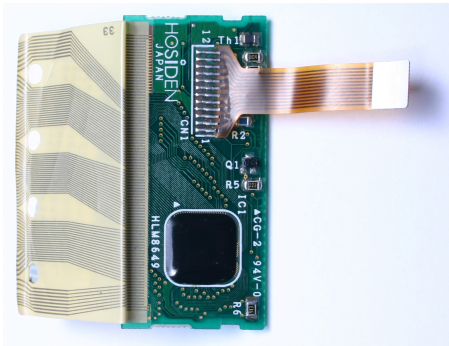

normal pads. Constraint rules can be set for min and max length of the bond wire from the die pad, and for the insulation status of the bond wires. Conditional Spacing rules can be defined for Chip-On-Board devices that use smaller values for this type of detailing. This is a mandatory requirement when mixing conventional and bare die technologies.

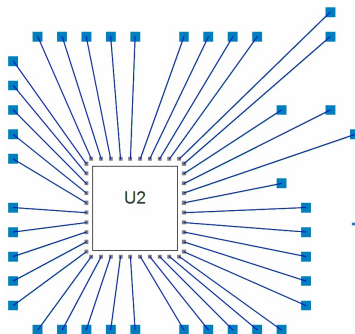

Embedded Components Support

The Pulsonix Embedded Component option supports technologies for printed passive resistors, capacitive dielectric layers, embedded planar converter or transformers plus buried semiconductors and thinned dies. Passive carbon resistors and similar technologies can be printed on inner layers but uniquely defined in the Pulsonix rule set. Pulsonix enables you to associate the necessary additional manufacturing layers for the resistive and other materials with the correct inner copper layer. Dielectric layers are defined using specific rule sets and materials. Planar transformers can consist of spiralled copper connected using vias or pads, special rules and design rules checking are applied to facilitate this technology. Pulsonix has also been developed well beyond the current commercial capabilities with the introduction of 'thinned' dies and buried semiconductors into inner layer substrates.

Advanced technologies within Pulsonix enabled truly embedded Components to be created

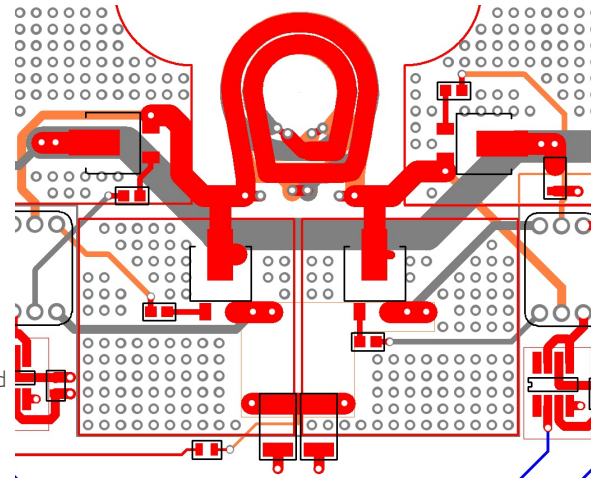

Feature Summary

- Unique Chip-on-board facility
- True Bond & Die pad support
- Constraint rules for min/max length
- Wire insulation rules & DRC checks
- Bond pad pattern algorithms
- Chip body placement in Component

- Embedded Component Technology
- Buried carbon/printed resistors
- Dielectric layer support for Capacitors
- Planar convertor/transformer support
- Embedded semiconductor support
- Thinned die support

The Pulsonix Chip-On-Board option offers a high technology but no fuss approach while design space is a premium



Pulsonix

20 Miller Court, Severn Drive,
Tewkesbury, Glos, GL20 8DN
United Kingdom

Tel: +44 (0)1684 296 551
E-mail: sales@pulsonix.com
www.pulsonix.com

Download a free unlimited Trial copy from
our web site and try it for yourself...

www.pulsonix.com

